

# Van Zile Typical 1PP

All dimensions approximate  
Typical ceiling height 8'

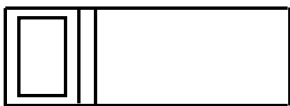

Twin XL Bed:  
Loftable Wooden Frame:  
6' 9" L x 3' 2" W  
Adjustable Height: 1' - 5' 2"

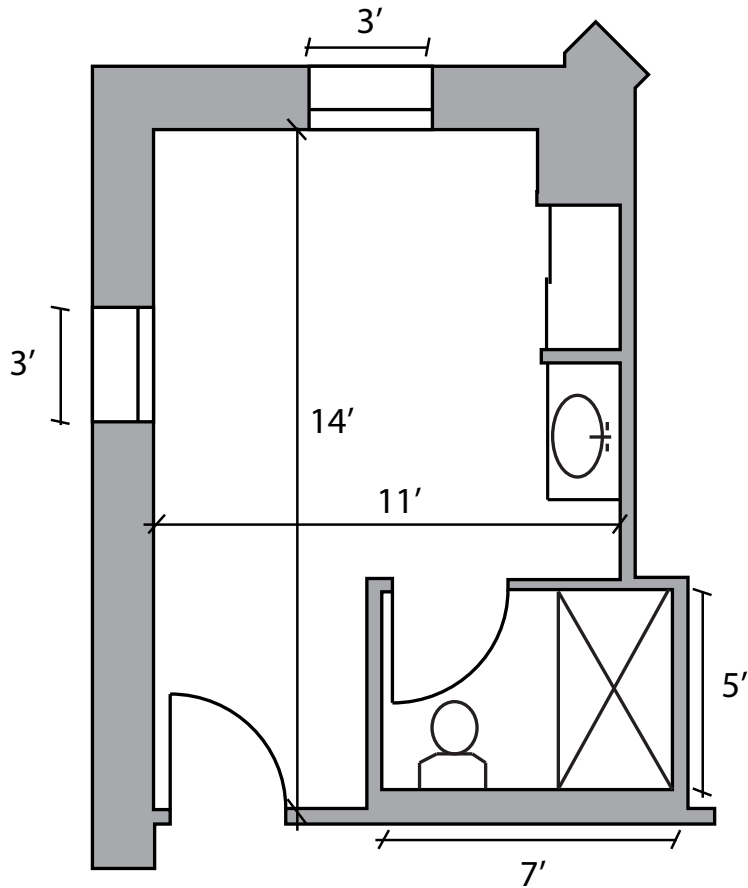
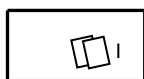

Desk:  
3' 6" L x 2' W x 2' 6" H



Dresser:  
2' 6" L x 2' W x 2' 6" H  
Drawers-  
2' 2" L x 1' 8" W x 6" H

# Van Zile Typical 1x1 Suite

All dimensions approximate  
Typical ceiling height 8'

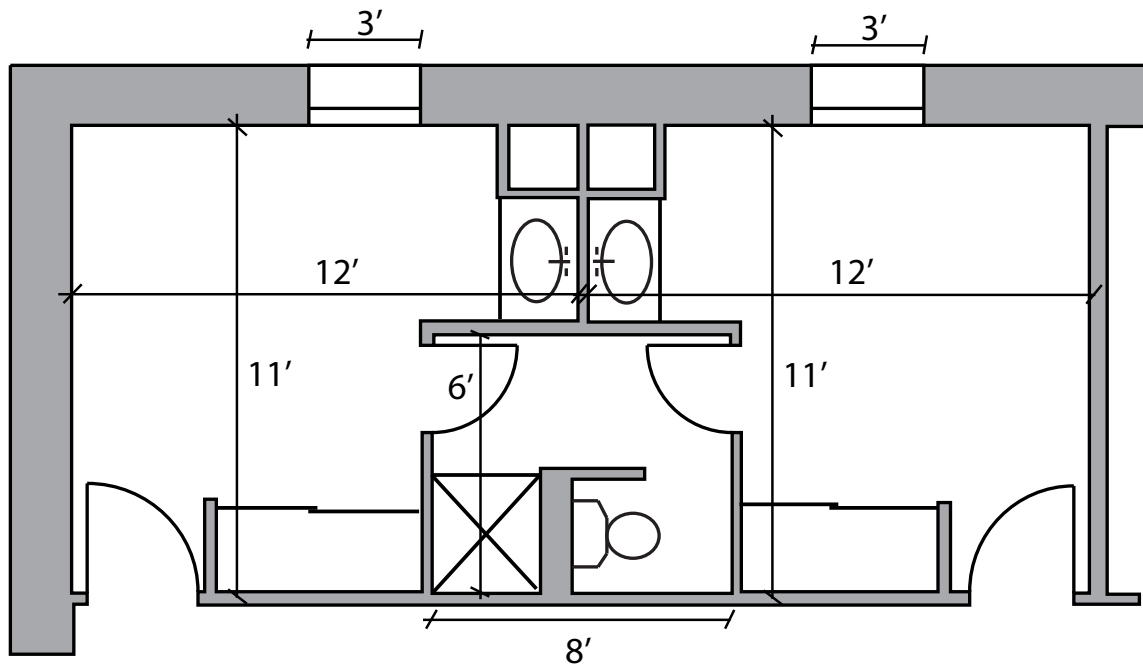

Twin XL Bed:  
Loftable Wooden Frame:  
6' 9" L x 3' 2" W  
Adjustable Height: 1' - 5' 2"

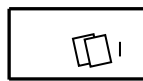

Desk:  
3' 6" L x 2' W x 2' 6" H



Dresser:  
2' 6" L x 2' W x 2' 6" H  
Drawers-  
2' 2" L x 1' 8" W x 6" H

# Van Zile Typical 1x 2 Suite, Version A

All dimensions approximate  
Typical ceiling height 8'

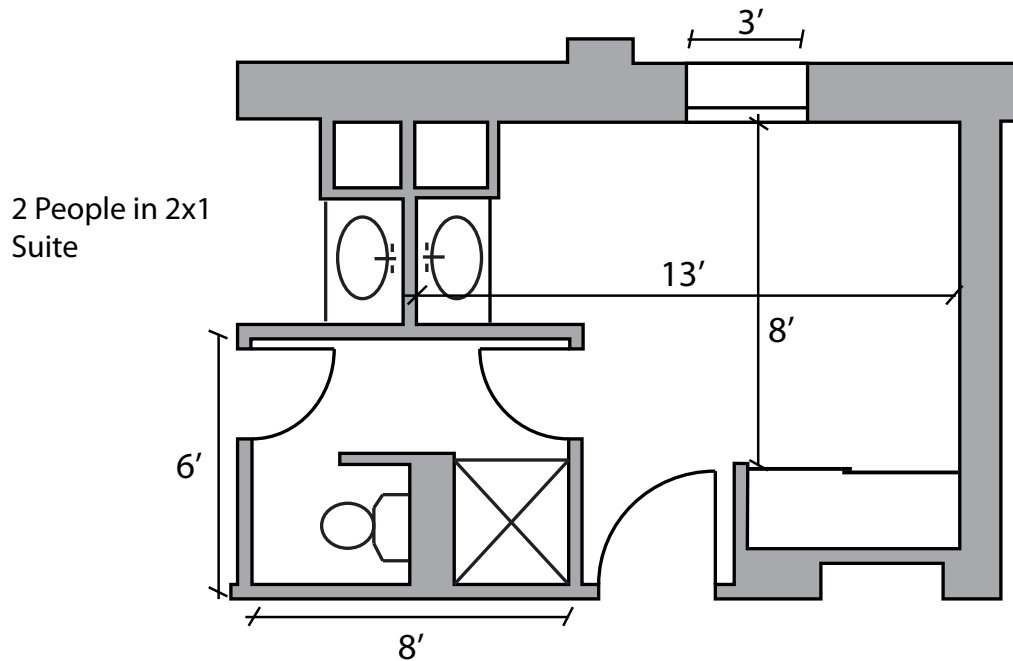

Twin XL Bed:  
Loftable Wooden Frame:  
6' 9" L x 3' 2" W  
Adjustable Height: 1' - 5' 2"

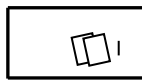

Desk:  
3' 6" L x 2' W x 2' 6" H



Dresser:  
2' 6" L x 2' W x 2' 6" H  
Drawers-  
2' 2" L x 1' 8" W x 6" H

# Van Zile Typical 1x 2 Suite, Version B

All dimensions approximate  
Typical ceiling height 8'

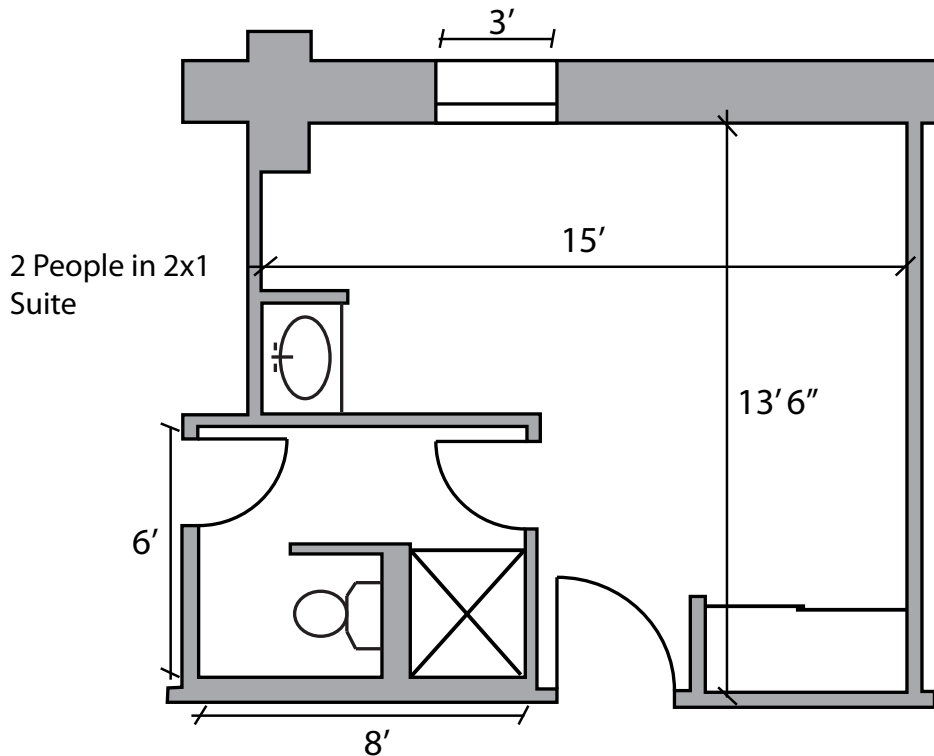

Twin XL Bed:  
Loftable Wooden Frame:  
6' 9" L x 3' 2" W  
Adjustable Height: 1' - 5' 2"

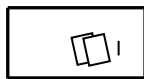

Desk:  
3' 6" L x 2' W x 2' 6" H



Dresser:  
2' 6" L x 2' W x 2' 6" H  
Drawers-  
2' 2" L x 1' 8" W x 6" H

# Van Zile Typical 2PP Suite

All dimensions approximate  
Typical ceiling height 8'

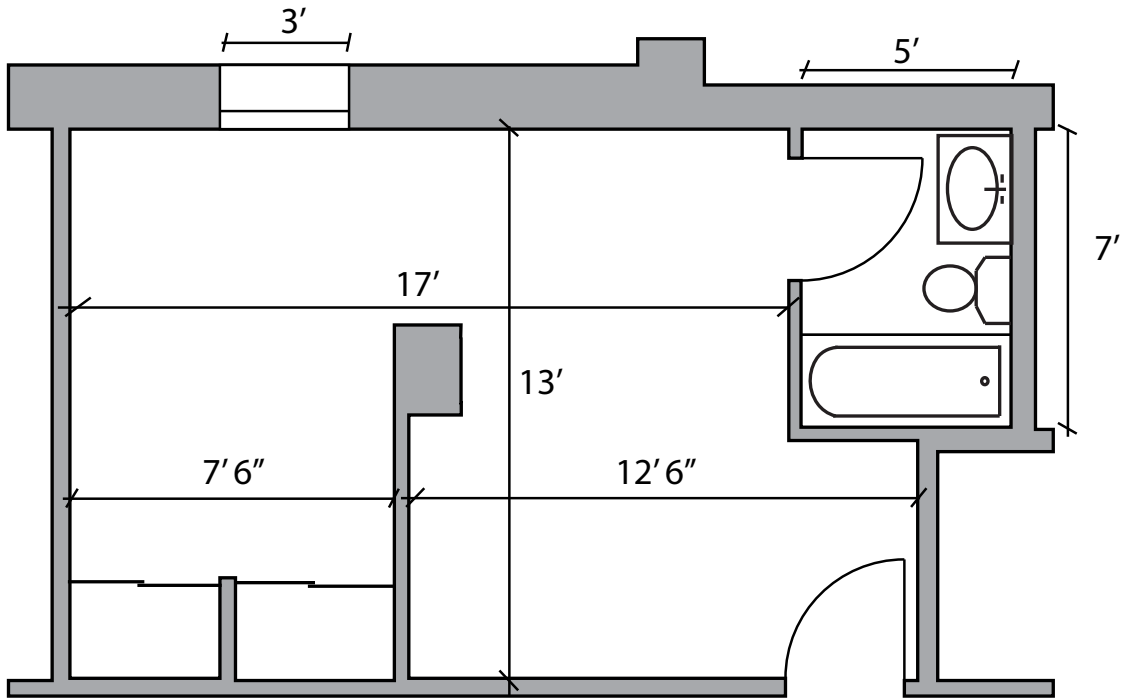

Twin XL Bed:  
Loftable Wooden Frame:  
6' 9" L x 3' 2" W  
Adjustable Height: 1' - 5' 2"

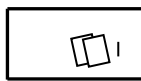

Desk:  
3' 6" L x 2' W x 2' 6" H



Dresser:  
2' 6" L x 2' W x 2' 6" H  
Drawers-  
2' 2" L x 1' 8" W x 6" H

# Van Zile Typical 2 x1 Suite, Version B

All dimensions approximate  
 Typical ceiling height 8'

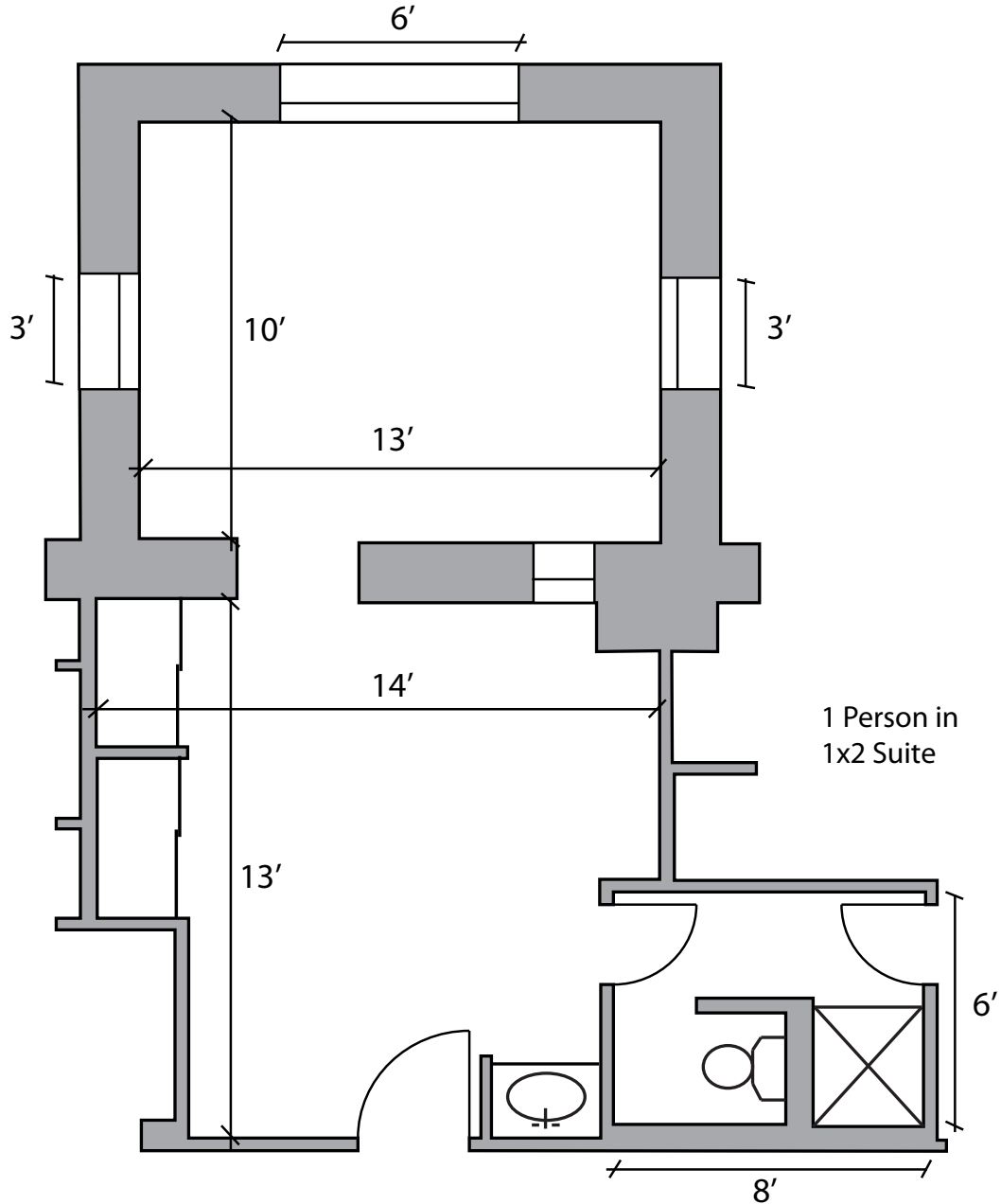

Twin XL Bed:  
 Loftable Wooden Frame:  
 6' 9" L x 3' 2" W  
 Adjustable Height: 1' - 5' 2"

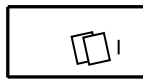

Desk:  
 3' 6" L x 2' W x 2' 6" H



Dresser:  
 2' 6" L x 2' W x 2' 6" H  
 Drawers-  
 2' 2" L x 1' 8" W x 6" H

# Van Zile Typical 2 x2 Suite

All dimensions approximate  
Typical ceiling height 8'

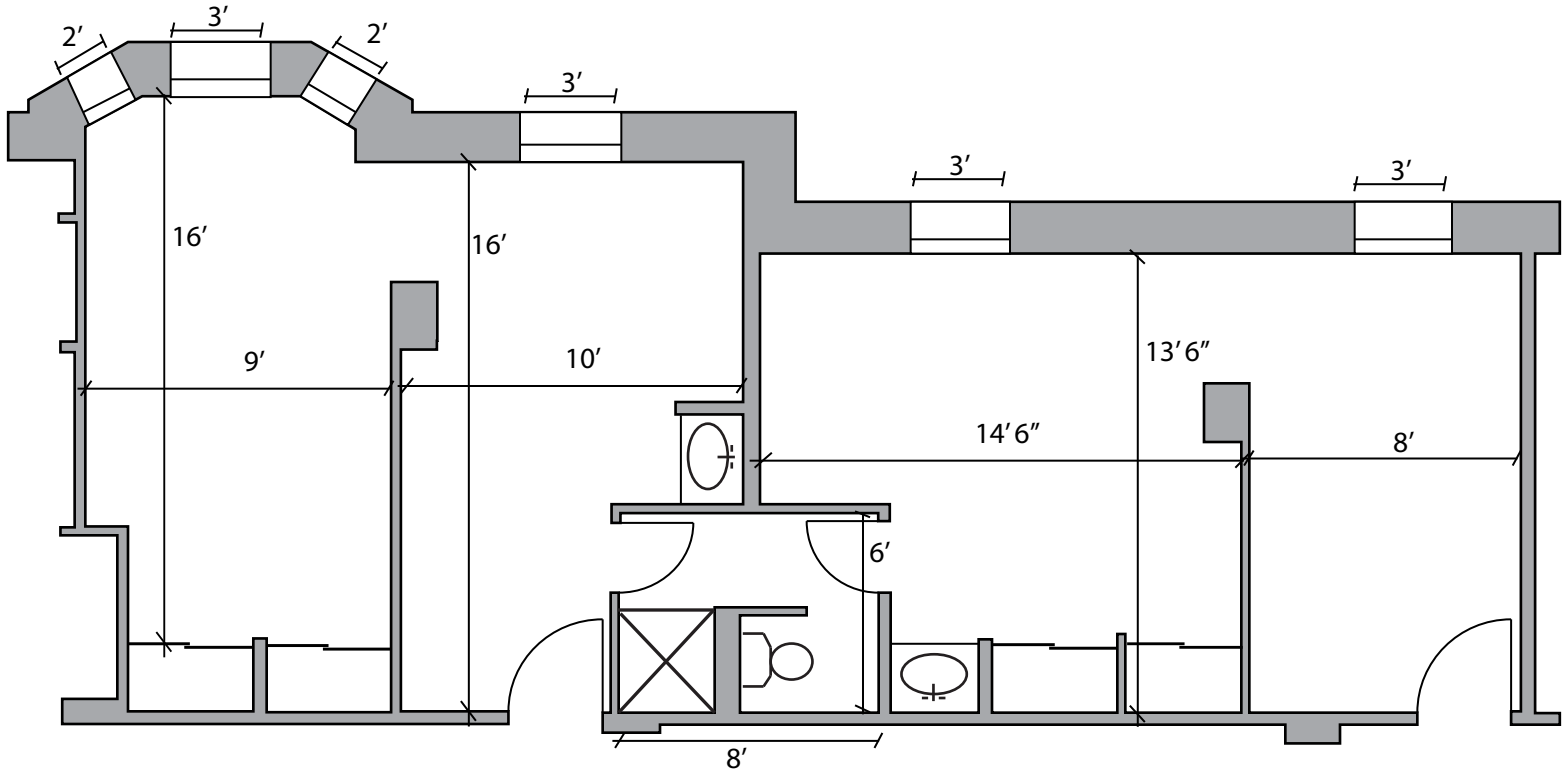

Twin XL Bed:  
Loftable Wooden Frame:  
6' 9" L x 3' 2" W  
Adjustable Height: 1' - 5' 2"



Desk:  
3' 6" L x 2' W x 2' 6" H



Dresser:  
2' 6" L x 2' W x 2' 6" H  
Drawers-  
2' 2" L x 1' 8" W x 6" H

# Van Zile Typical 2 x1 Suite, Version A

All dimensions approximate  
 Typical ceiling height 8'

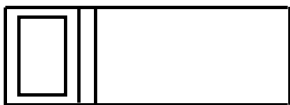
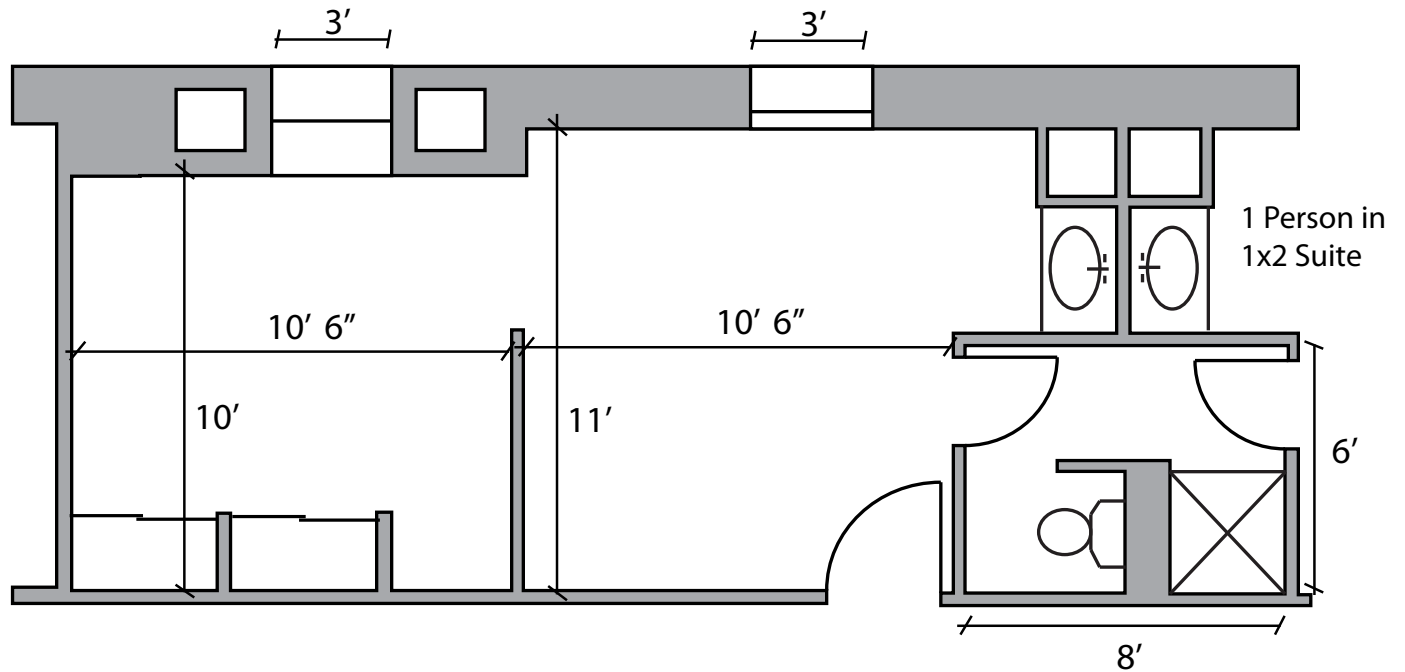

Twin XL Bed:  
 Loftable Wooden Frame:  
 6' 9" L x 3' 2" W  
 Adjustable Height: 1' - 5' 2"

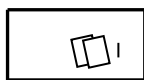

Desk:  
 3' 6" L x 2' W x 2' 6" H



Dresser:  
 2' 6" L x 2' W x 2' 6" H  
 Drawers-  
 2' 2" L x 1' 8" W x 6" H